

RLV 210 PMEV210

RLV, PMEV200시리즈, 1/8, 5/2Way, 메카니컬 밸브

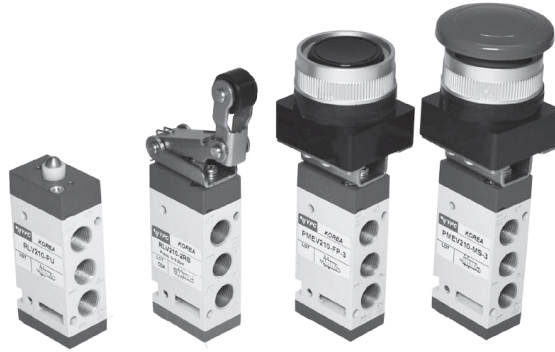

- ◆ 성능 및 내구성향상
- ◆ 직동형작동
- ◆ 장수명
- ◆ 액추에이터 다양화
- ◆ 무급유 타입

◆ 주문형식 표기방법

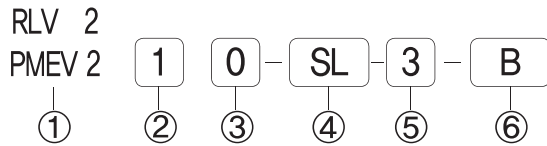

- ① **시리즈**
RLV200 시리즈
PMEV200 시리즈
 - ② **복귀방식**
1 : 5/2 스프링리턴
 - ③ **관접속구경**
0 : 1/8
1 : NPT 1/8
 - ④ **액추에이터**
PU : 기본형
1RP : 롤러레버
1RB : 롤러레버 베어링
2RP : 2단롤러레버(1방향)
 - ⑤ **스위치 판넬규격**
3 : 판넬취부 Ø30 (표준)
2 : 판넬취부 Ø25
 - ⑥ **스위치 컬러(FP, MS)**
무기호 : 기본컬러(R)
R : 레드컬러
G : 그린컬러
B : 블랙컬러
- 2RB : 2단 롤러레버 베어링(1방향)
FP : 누름버튼
MS : 비상버튼(버섯형)
SL : 2위치 셀렉터
MT : 2위치 비상정지

◆ 사양

절환방식	5포트 2위치
사용유체	공기 및 불활성 가스
사용압력	0.0~0.8 Mpa
유효단면적(mm ²)	12.6
주위 및 사용유체온도	5 ~ 60° (41~ 140°F)
급 유	불필요
접속구경	1/8

◆ 밸브형식

동작방식	모 델	액추에이터	부품품번	유효단면적mm ²
기계조작	RLV210-PU	기본형	-	12.6mm ²
	RLV210-1RP	롤러레버	RLV2-1RP	
	RLV210-1RB	롤러레버 베어링	RLV2-1RB	
	RLV210-2RP	2단 롤러레버(1방향)	RLV2-2RP	
	RLV210-2RB	2단 롤러레버 베어링(1방향)	RLV2-2RB	
수동조작	PMEV210-FP-3	누름버튼	PMEV2-FP-3	
	PMEV210-MS-3	바상버튼(버섯형)	PMEV2-MS-3	
	PMEV210-SL-3	2위치 셀렉터	PMEV2-SL-3	
	PMEV210-MT-3	2위치 비상정지	PMEV2-MT-3	

◆ 밸브형식

초기상태

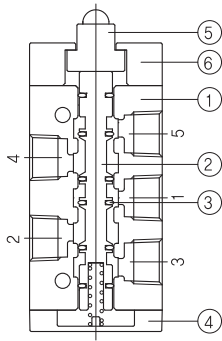

작동상태

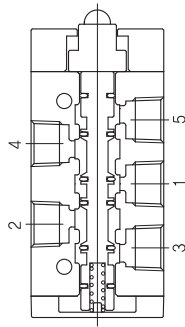

◆ 구성부품

번호	부품명	비고
①	바디	알루미늄 다이캐스팅
②	스플	알루미늄
③	패킹	NBR
④	바디캡	알루미늄 다이캐스팅
⑤	버튼	탄소강
⑥	파일럿트	아연 다이캐스팅

▶ 기본형

RLV210-PU

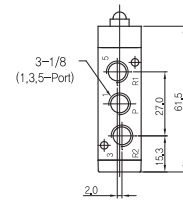
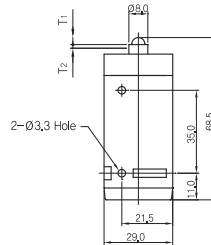
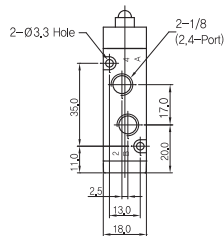
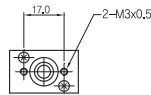

T1	유효 동작 거리	2,0mm
T2	무효 동작 거리	1,0mm
F1	유효 조작에 필요한 하중	2,0kg
F2	무효 조작에 필요한 하중	2,0kg

▶ 1단 롤러레버

RLV210-1RP

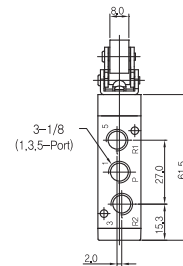
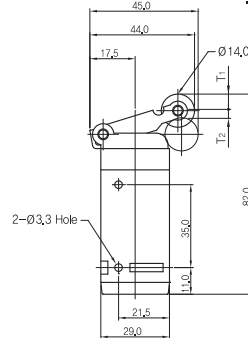
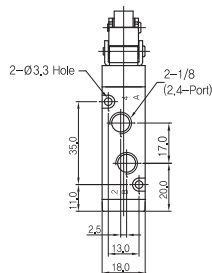
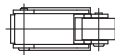

T1	유효 동작 거리	6,0mm
T2	무효 동작 거리	2,0mm
F1	유효 조작에 필요한 하중	1,0kg
F2	무효 조작에 필요한 하중	1,0kg

◆ 밸브 치수도

▶ 1단 롤러레버 베어링

RLV210-1RB

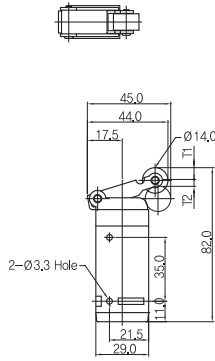
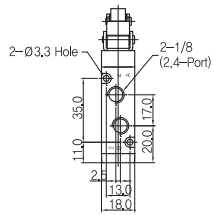

T1	유효 동작 거리	8,0mm
T2	무효 동작 거리	3,0mm
F1	유효 조작에 필요한 하중	2,0kg
F2	무효 조작에 필요한 하중	

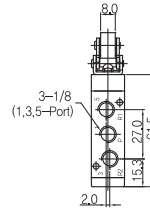

▶ 2단 롤러레버 1방향

RLV210-2RP

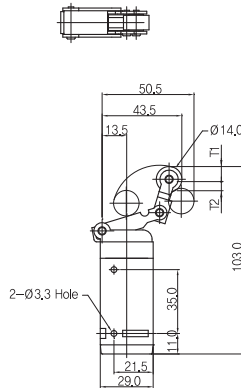
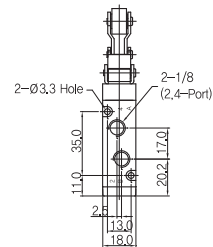
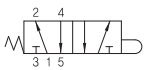

T1	유효 동작 거리	9,0mm
T2	무효 동작 거리	3,5mm
F1	유효 조작에 필요한 하중	2,0kg
F2	무효 조작에 필요한 하중	

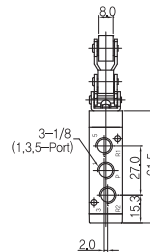

▶ 2단 롤러레버 베어링 1방향

RLV210-2RB

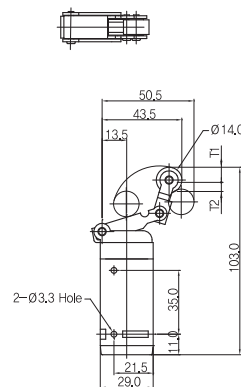
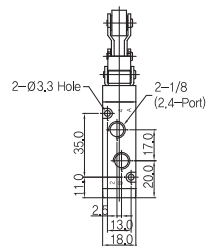

T1	유효 동작 거리	9,0mm
T2	무효 동작 거리	3,5mm
F1	유효 조작에 필요한 하중	2,0kg
F2	무효 조작에 필요한 하중	

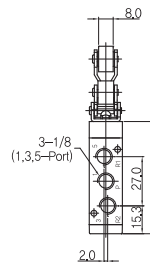

◆ 밸브 치수도

▶ 누름버튼 매립형

PMEV210-FP-3

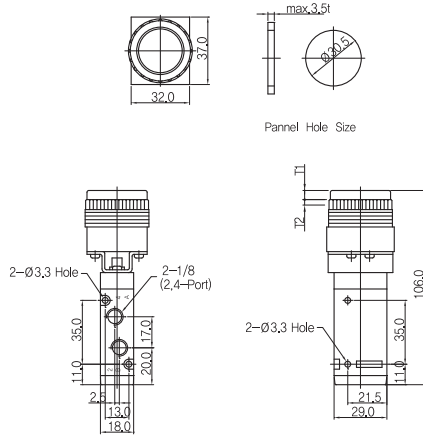
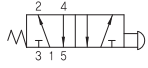

T1	유효 동작 거리	5,5mm
T2	무효 동작 거리	1,0mm
F1	유효 조작에 필요한 하중	3,5kg
F2	무효 조작에 필요한 하중	

▶ 바상버튼 버섯형

PMEV210-MS-3

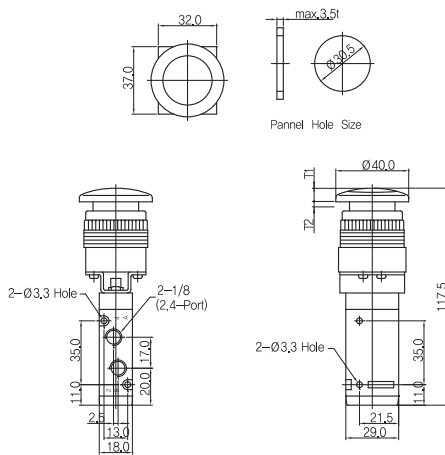

T1	유효 동작 거리	5,5mm
T2	무효 동작 거리	1,0mm
F1	유효 조작에 필요한 하중	3,5kg
F2	무효 조작에 필요한 하중	

▶ 2위치 셀렉터

PMEV210-SL-3

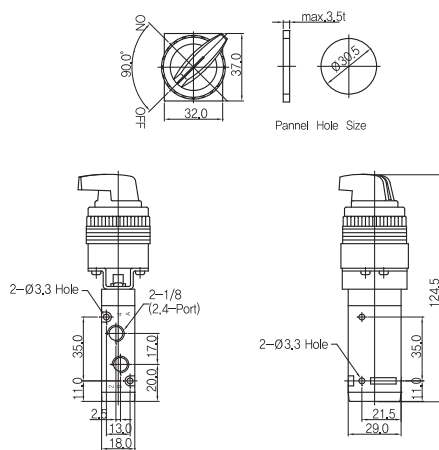

T1	유효 동작 거리	4,0mm
T2	무효 동작 거리	
F1	유효 조작에 필요한 하중	3,5kg
F2	무효 조작에 필요한 하중	

◆ 밸브 치수도

▶ 비상정지

PMEV210-MT-3

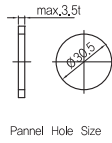
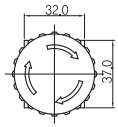
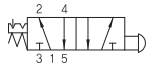

T1	유효 동작 거리	4.0mm
T2	무효 동작 거리	
F1	유효 조작에 필요한 하중	3.5kg
F2	무효 조작에 필요한 하중	

