

# YMV400

YMV400시리즈 ,1/4, 3/2Way, 표준형 메카니컬 밸브



- ◆ 성능 및 내구성향상
- ◆ 직동형작동
- ◆ 장수명
- ◆ 액추에이터 다양화
- ◆ 무급유 타입

### ◆ 주문형식 표기방법

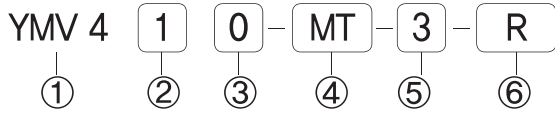

- ① 시리즈  
YMV400 시리즈
- ② 복귀방식  
1 : 스프링리턴
- ③ 관접속구경  
0 : 1/4  
1 : NPT 1/4
- ④ 액추에이터  
PU : 기본형  
1RP : 롤러레버  
1RB : 롤러레버 베어링  
2RP : 2단롤러레버(1방향)  
2RB : 2단 롤러레버 베어링(1방향)
- FP : 누름버튼  
MS : 비상버튼(버섯형)  
SL : 2위치 선택터  
MT : 2위치 비상정지
- ⑤ 스위치 판별규격  
3 : 판넬취부 Ø30 (표준)  
2 : 판넬취부 Ø25
- ⑥ 스위치 컬러(FP, MS)  
무기호 : 기본컬러(R)  
R : 레드컬러  
G : 그린컬러  
B : 블랙컬러

### ◆ 사양

절환방식	3포트 2위치
사용유체	공기 및 불활성 가스
사용압력	0.0~0.8 Mpa
유효단면적(mm <sup>2</sup> )	16.0
주위 및 사용유체온도	5 ~ 60° (41~ 140°F)
급 유	불필요
접속구경	1/4

### ◆ 밸브형식

동작방식	모 델	액추에이터	부품품번	유효단면적mm <sup>2</sup>
기계조작	YMV410-PU	기본형	-	16.0mm <sup>2</sup>
	YMV410-1RP	롤러레버	YMV3-1RP	
	YMV410-1RB	롤러레버 베어링	YMV3-1RB	
	YMV410-2RP	2단롤러레버(1방향)	YMV3-2RP	
	YMV410-2RB	2단롤러레버 베어링(1방향)	YMV3-2RB	
수동조작	YMV410-FP-3	누름버튼	YMV3-FP-3	
	YMV410-MS-3	비상버튼(버섯형)	YMV3-MS-3	
	YMV410-SL-3	2위치 선택터	YMV3-SL-3	
	YMV410-MT-3	2위치 비상정지	YMV3-MT-3	

◆ 밸브형식

초기상태

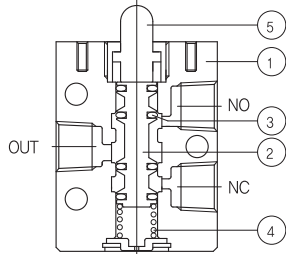

작동상태

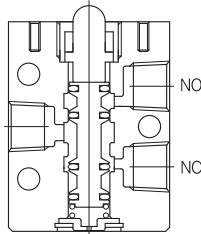

◆ 구성부품

번호	부품명	비고
①	바디	알루미늄 다이캐스팅
②	스플	알루미늄
③	패킹	NBR
④	스프링	스테인레스
⑤	버튼	탄소강

▶ 기본형

YMV410-PU

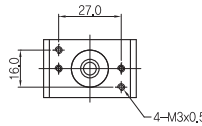
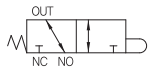

T1	유효동작거리	8,0mm
T2	무효동작거리	1,0mm
F1	유효조작하중	3,5kg
F2	무효조작하중	

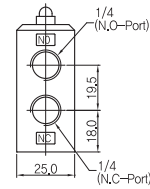
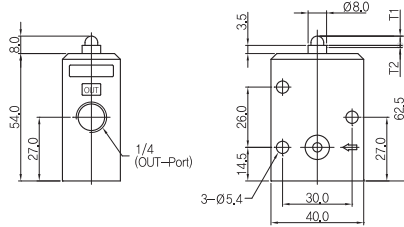

▶ 1단 롤러레버

YMV410-1RP

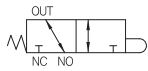

T1	유효 동작 거리	8,0mm
T2	무효 동작 거리	3,0mm
F1	유효 조작에 필요한 하중	2,0kg
F2	무효 조작에 필요한 하중	

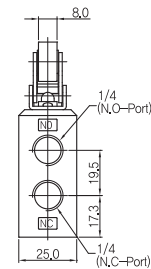
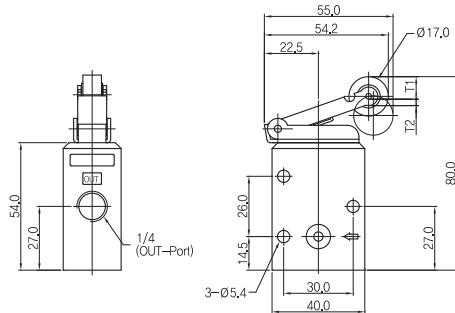

◆ 밸브치수도

▶ 1단 롤러레버 베어링

YMV410-1RB

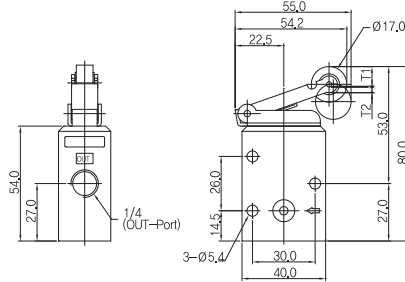

T1	유효 동작 거리	8,0mm
T2	무효 동작 거리	3,0mm
F1	유효 조작에 필요한 하중	2,0kg
F2	무효 조작에 필요한 하중	

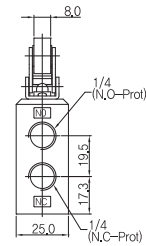

▶ 2단 롤러레버 1방향

YMV410-2RP

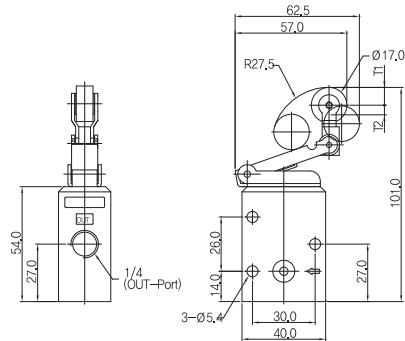
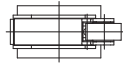
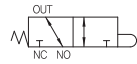

T1	유효 동작 거리	9,0mm
T2	무효 동작 거리	3,5mm
F1	유효 조작에 필요한 하중	2,0kg
F2	무효 조작에 필요한 하중	

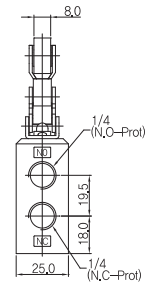

▶ 2단 롤러레버 베어링 1방향

YMV410-2RB

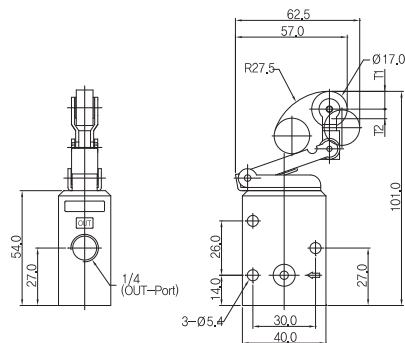
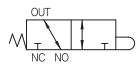

T1	유효 동작 거리	9,0mm
T2	무효 동작 거리	3,5mm
F1	유효 조작에 필요한 하중	2,0kg
F2	무효 조작에 필요한 하중	

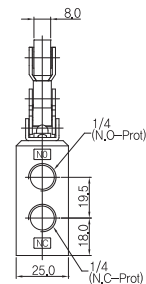

◆ 밸브치수도

▶ 누름버튼 매립형

YMV410-FP-3

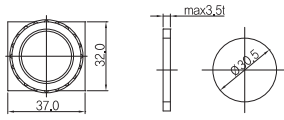
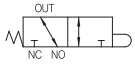

Panel Hole Size

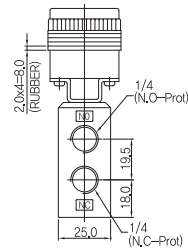
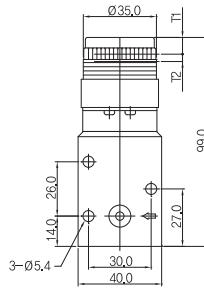
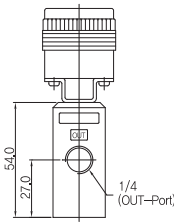

T1	유효 동작 거리	5,5mm
T2	무효 동작 거리	1,0mm
F1	유효 조작에 필요한 하중	3,5kg
F2	무효 조작에 필요한 하중	

▶ 비상버튼 버섯형

YMV410-MS-3

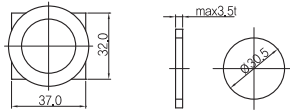

Panel Hole Size

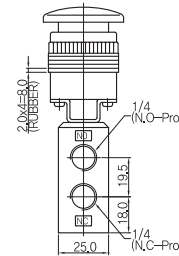
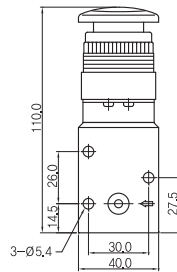
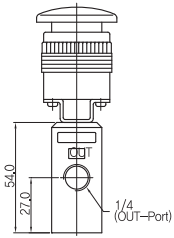

T1	유효 동작 거리	5,5mm
T2	무효 동작 거리	1,0mm
F1	유효 조작에 필요한 하중	3,5kg
F2	무효 조작에 필요한 하중	

▶ 2위치 셀렉터

YMV410-SL-3

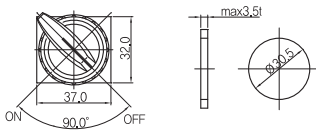
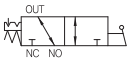

Panel Hole Size

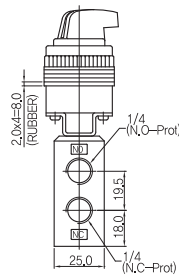
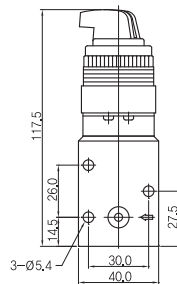
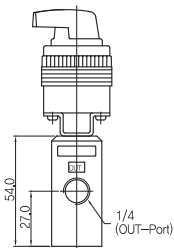

T1	유효 동작 거리	4,0mm
T2	무효 동작 거리	
F1	유효 조작에 필요한 하중	3,5kg
F2	무효 조작에 필요한 하중	

◆ 밸브 치수도

▶ 비상정지

YMV410-MT-3

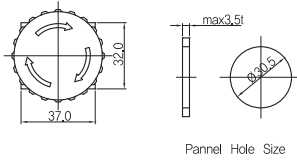
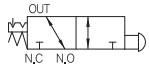

Pannel Hole Size

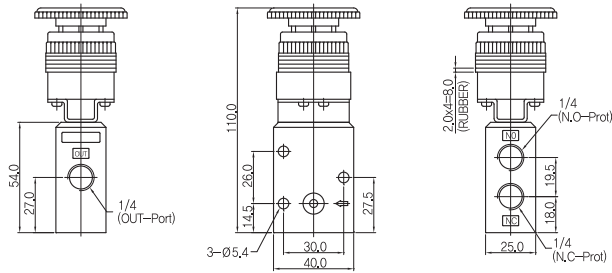

T1	유효 동작 거리	4.0mm
T2	무효 동작 거리	
F1	유효 조작에 필요한 하중	3.5kg
F2	무효 조작에 필요한 하중	